

Makita

アメリカ

Straight Shear

MODEL JS1670

INSTRUCTION MANUAL

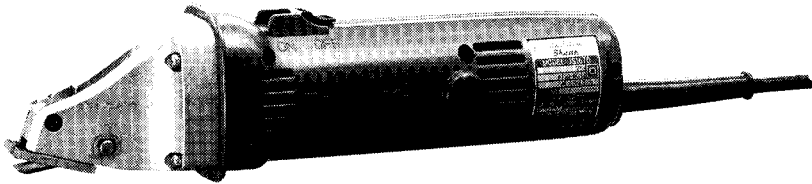

SPECIFICATIONS

Max. cutting capacities					Strokes per minute	Overall length	Net weight
Mild steel	Hard steel	Stainless	Aluminum	Min cutting radius			
1.0 mm (3/64")	0.7 mm (1/32")	0.7 mm (1/32")	1.5 mm (1/16")	30 mm (1-1/8")	4,500	306 mm (12")	1.3 kg (2.9 lbs)

- * Manufacturer reserves the right to change specifications without notice.
- Note: Specifications may differ from country to country.

IMPORTANT SAFETY INSTRUCTIONS

(For All Tools)

WARNING: WHEN USING ELECTRIC TOOLS, BASIC SAFETY PRECAUTIONS SHOULD ALWAYS BE FOLLOWED TO REDUCE THE RISK OF FIRE, ELECTRIC SHOCK, AND PERSONAL INJURY, INCLUDING THE FOLLOWING:

READ ALL INSTRUCTIONS.

1. **KEEP WORK AREA CLEAN.** Cluttered areas and benches invite injuries.
2. **CONSIDER WORK AREA ENVIRONMENT.** Don't use power tools in damp or wet locations. Keep work area well lit. Don't expose power tools to rain. Don't use tool in presence of flammable liquids or gases.
3. **KEEP CHILDREN AWAY.** All visitors should be kept away from work area. Don't let visitors contact tool or extension cord.
4. **STORE IDLE TOOLS.** When not in use, tools should be stored in dry, and high or locked-up place — out of reach of children.
5. **DON'T FORCE TOOL.** It will do the job better and safer at the rate for which it was intended.
6. **USE RIGHT TOOL.** Don't force small tool or attachment to do the job of a heavy-duty tool. Don't use tool for purpose not intended; for example, don't use circular saw for cutting tree limbs or logs.
7. **DRESS PROPERLY.** Don't wear loose clothing or jewelry. They can be caught in moving parts. Rubber gloves and non-skid footwear are recommended when working outdoors. Wear protective hair covering to contain long hair.
8. **USE SAFETY GLASSES.** Also use face or dust mask if cutting operation is dusty.
9. **DON'T ABUSE CORD.** Never carry tool by cord or yank it to disconnect from receptacle. Keep cord from heat, oil, and sharp edges.
10. **SECURE WORK.** Use clamps or a vise to hold work. It's safer than using your hand and it frees both hands to operate tool.
11. **DON'T OVERREACH.** Keep proper footing and balance at all times.
12. **MAINTAIN TOOLS WITH CARE.** Keep tools sharp and clean for better and safer performance. Follow instructions for lubricating and changing accessories. Inspect tool cords periodically and if damaged, have repaired by authorized service facility. Inspect extension cords periodically and replace if damaged. Keep handles dry, clean, and free from oil and grease.
13. **DISCONNECT TOOLS.** When not in use, before servicing, and when changing accessories, such as blades, bits, cutters.

14. **REMOVE ADJUSTING KEYS AND WRENCHES.** Form habit of checking to see that keys and adjusting wrenches are removed from tool before turning it on.
15. **AVOID UNINTENTIONAL STARTING.** Don't carry tool with finger on switch. Be sure switch is OFF when plugging in.
16. **EXTENSION CORDS.** Make sure your extension cord is in good condition. When using an extension cord, be sure to use one heavy enough to carry the current your product will draw. An undersized cord will cause a drop in line voltage resulting in loss of power and overheating. Table 1 shows the correct size to use depending on cord length and nameplate ampere rating. If in doubt, use the next heavier gage. The smaller the gage number, the heavier the cord.

TABLE 1 MINIMUM GAGE FOR CORD SETS

			Total Length of Cord in Feet			
			0 – 25	26 – 50	51 – 100	101 – 150
Ampere Rating More Than	—	Not More Than	A W G			
0	—	6	18	16	16	14
6	—	10	18	16	14	12
10	—	12	16	16	14	12
12	—	16	14	12	Not Recommended	

17. **OUTDOOR USE EXTENSION CORDS.** When tool is used outdoors, use only extension cords intended for use outdoors and so marked.
18. **STAY ALERT.** Watch what you are doing, use common sense. Don't operate tool when you are tired.
19. **CHECK DAMAGED PARTS.** Before further use of the tool, a guard or other part that is damaged should be carefully checked to determine that it will operate properly and perform its intended function. Check for alignment of moving parts, binding of moving parts, breakage of parts, mounting, and any other conditions that may affect its operation. A guard or other part that is damaged should be properly repaired or replaced by an authorized service center unless otherwise indicated elsewhere in this instruction manual. Have defective switches replaced by authorized service center. Don't use tool if switch does not turn it on and off.
20. **GUARD AGAINST ELECTRIC SHOCK.** Prevent body contact with grounded surfaces. For example; pipes, radiators, ranges, refrigerator enclosures.
21. **REPLACEMENT PARTS.** When servicing, use only identical replacement parts.
22. **POLARIZED PLUGS.** To reduce the risk of electric shock, this equipment has a polarized plug (one blade is wider than the other). This plug will fit in a polarized outlet only one way. If the plug does not fit fully in the outlet, reverse the plug. If it still does not fit, contact a qualified electrician to install the proper outlet. Do not change the plug in any way.

VOLTAGE WARNING: Before connecting the tool to a power source (receptacle, outlet, etc.) be sure the voltage supplied is the same as that specified on the nameplate of the tool. A power source with voltage greater than that specified for the tool can result in **SERIOUS INJURY** to the user — as well as damage to the tool. If in doubt, **DO NOT PLUG IN THE TOOL**. Using a power source with voltage less than the nameplate rating is harmful to the motor.

ADDITIONAL SAFETY RULES

1. Secure the workpiece firmly.
2. Edges and chips of the workpiece are sharp. So, be careful.

SAVE THESE INSTRUCTIONS.

Lubrication

Before operation, lubricate the contact point of the center blade and the pin. To keep good cutting performance, also use a cutting lubricant from time to time during operation.

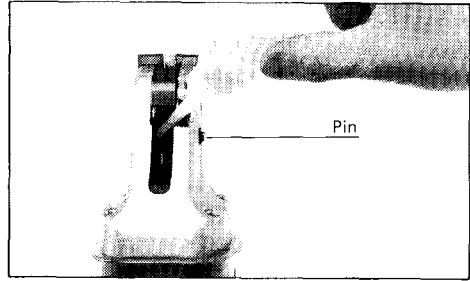

Switch action

To start the tool, move the slide switch forward, and the slide switch will lock in the "ON" position. To stop, lightly depress the rear of the slide switch, and it will return to the "OFF" position.

CAUTION:

Before plugging in the tool, always check to see that the slide switch actuates properly and returns to the "OFF" position when depressed.

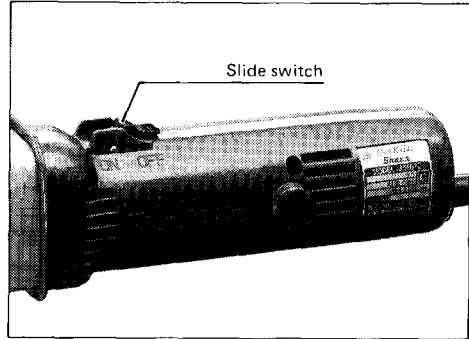

Operation

Turn the tool on and set the front ends of the side blades on the workpiece. Now simply move the tool forward, keeping the side blades flush with the workpiece surface. When cutting curves, advance the tool very slowly.

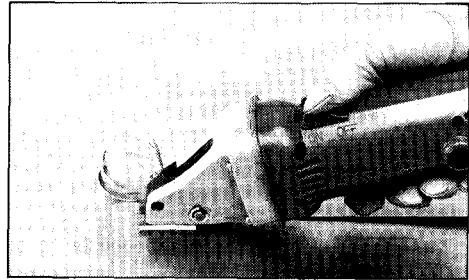

CAUTION:

When cutting a small portion of the workpiece, you may have difficulty completing the end of the cut. In that case, try to cut it again, pulling the workpiece back slightly.

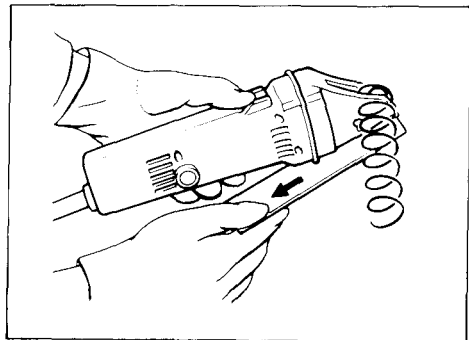

MAINTENANCE

CAUTION:

Always be sure that the tool is switched off and unplugged before attempting to perform inspection or maintenance.

Replacing carbon brushes

Remove and check the carbon brushes regularly. Replace when they wear down to the limit mark. Keep the carbon brushes clean and free to slip in the holders. Both carbon brushes should be replaced at the same time. Use only identical carbon brushes.

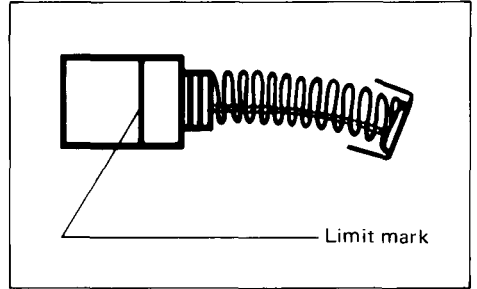

Use a screwdriver to remove the brush holder caps. Take out the worn carbon brushes, insert the new ones and secure the brush holder caps.

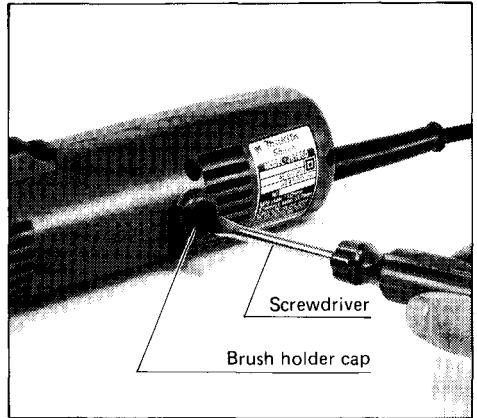

Replacing blades

The service life of the blades varies in terms of the workpiece to be cut. The following reference table indicates the approximate service life of the blades. When the blades become dull, ask Makita Authorized or Factory Service Centers to replace the blades.

Workpiece	Cutting thickness	Cutting length
Mild steel	1.0 mm (3/64")	120 m (394 ft.)
Hard steel	0.7 mm (1/32")	100 m (328 ft.)
Stainless	0.7 mm (1/32")	50 m (164 ft.)
Aluminum	1.5 mm (1/16")	300 m (984 ft.)

To maintain product SAFETY and RELIABILITY, repairs, any other maintenance or adjustment should be performed by Makita Authorized or Factory Service Centers, always using Makita replacement parts.

ACCESSORIES

CAUTION:

These accessories or attachments are recommended for use with your Makita tool specified in this manual. The use of any other accessories or attachments might present a risk of injury to persons. The accessories or attachments should be used only in the proper and intended manner.

- **Hex wrench 3**

Part No. 783201-2



- **Wrench holder**

Part No. 410048-8

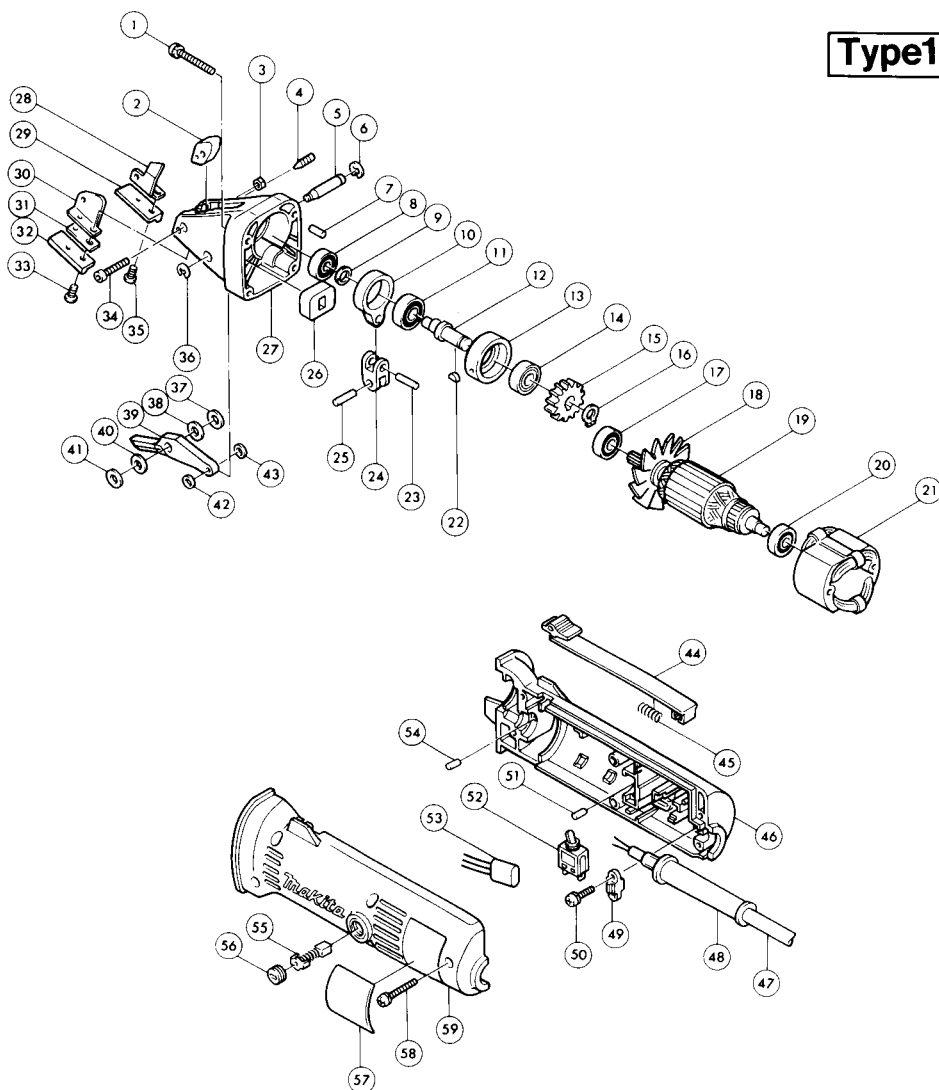

STRAIGHT SHEAR Model JS1670

Type1

Note: The switch, noise suppressor and other part configurations may differ from country to country.

ITEM NO.	NO. USED	DESCRIPTION	ITEM NO.	NO. USED	DESCRIPTION
MACHINE			MACHINE		
1	4	Pan Head Screw M4x35 (With Washer)	30	1	Slip Plate L
2	1	Block	31	1	Spacer
3	1	Hex. Lock Nut M4-7	32	1	Side Blade
4	1	Set Screw M5x12	33	1	Hex. Socket Head Bolt M5x10
5	1	Pin 7	34	1	Hex. Socket Head Bolt M4x25
6	1	Stop Ring E -6	35	1	Hex. Socket Head Bolt M5x10
7	1	Rubber Pin 4	36	1	Stop Ring E-4
8	1	Ball Bearing 627LLB	37	1	Teflon Washer 7
9	1	Flat Washer 7	38	1	Thin Washer 7
10	1	Rod	39	1	Center Blade
11	1	Ball Bearing 6000LB	40	1	Thin Washer 7
12	1	Crank Shaft	41	1	Teflon Washer 7
13	1	Bush	42	1	Flat Washer 5
14	1	Ball Bearing 6000LB	43	1	Flat Washer 5
15	1	Helical Gear 44	44	1	Switch Rod
16	1	Retaining Ring S-10	45	1	Compression Spring 6
17	1	Ball Bearing 608LB	46	1	Housing Set (With Item 59)
18	1	Fan 52	47	1	Cord
19	1	ARMATURE ASSEMBLY (With Item 17, 18 & 20)	48	1	Cord Guard
20	1	Ball Bearing 627LLB	49	1	Strain Relief
21	1	FIELD ASSEMBLY	50	2	Pan Head Screw M4x18 (With Washer)
22	1	Woodruff Key 3	51	1	Rubber Pin 4
23	1	Pin 5	52	1	Switch
24	1	Link	54	1	Rubber Pin 4
25	1	Pin 5	55	2	Carbon Brush
26	1	Dust Cover	56	2	Brush Holder Cap
27	1	Crank Housing	57	1	Name Plate
28	1	Slip Plate R	58	5	Pan Head Screw M4x30 (With Washer)
29	1	Side Blade	59	1	Housing Set (With Item 46)

Note: The switch and other part specifications may differ from country to country.



MAKITA LIMITED ONE YEAR WARRANTY

Warranty Policy

Every Makita tool is thoroughly inspected and tested before leaving the factory. It is warranted to be free of defects from workmanship and materials for the period of ONE YEAR from the date of original purchase. Should any trouble develop during this one-year period, return the COMPLETE tool, freight prepaid, to one of Makita's Factory or Authorized Service Centers. If inspection shows the trouble is caused by defective workmanship or material, Makita will repair (or at our option, replace) without charge.

This Warranty does not apply where:

- repairs have been made or attempted by others;
- repairs are required because of normal wear and tear;
- The tool has been abused, misused or improperly maintained;
- alterations have been made to the tool.

IN NO EVENT SHALL MAKITA BE LIABLE FOR ANY INDIRECT, INCIDENTAL OR CONSEQUENTIAL DAMAGES FROM THE SALE OR USE OF THE PRODUCT. THIS DISCLAIMER APPLIES BOTH DURING AND AFTER THE TERM OF THIS WARRANTY.

MAKITA DISCLAIMS LIABILITY FOR ANY IMPLIED WARRANTIES, INCLUDING IMPLIED WARRANTIES OF "MERCHANTABILITY" AND "FITNESS FOR A SPECIFIC PURPOSE," AFTER THE ONE-YEAR TERM OF THIS WARRANTY.

This Warranty gives you specific legal rights, and you may also have other rights which vary from state to state. Some states do not allow the exclusion or limitation of incidental or consequential damages, so the above limitation or exclusion may not apply to you. Some states do not allow limitation on how long an implied warranty lasts, so the above limitation may not apply to you.

Makita Corporation

3-11-8, Sumiyoshi-cho,
Anjo, Aichi 446 Japan

883601A069

PRINTED IN JAPAN
1995 - 3 - N